



AT&T

Quick start guide

DL72119/DL72219/DL72319/
DL72419/DL72519/DL72539/
DL72549

DECT 6.0 cordless telephone/
answering system with
BLUETOOTH® wireless technology



Congratulations

on your purchase of this AT&T product. Before using this AT&T product, please read the **Important safety information** section on pages 1-3 of this manual.

Both the model and serial numbers of your AT&T product can be found on the bottom of the telephone base. Save your sales receipt and original packaging in case it is necessary to return your telephone for warranty service.

For customer service, please visit our website at <https://telephones.att.com> or call **1 (800) 222-3111**. In Canada, dial **1 (866) 288-4268**.



Please refer to the online **DL72119/DL72219/DL72319/DL72419/DL72519/DL72539/DL72549** DECT 6.0 cordless telephone/answering system with BLUETOOTH® wireless technology Complete user's manual for a full set of installation and operation instructions at www.telephones.att.com/manuals.

Parts checklist

Your telephone package contains the following items.



Quick start guide



Smart call blocker leaflet

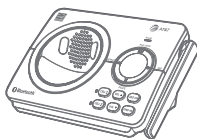

Telephone base



Power adapter for telephone base



Cordless handset
(1 for DL72119)
(2 for DL72219)
(3 for DL72319)
(4 for DL72419)
(5 for DL72519/
DL72539/DL72549)



Charger for cordless handset with power adapter installed
(1 for DL72219)
(2 for DL72319)
(3 for DL72419)
(4 for DL72519/DL72539/
DL72549)



Battery for cordless handset
(1 for DL72119)
(2 for DL72219)
(3 for DL72319)
(4 for DL72419)
(5 for DL72519/
DL72539/DL72549)



Battery compartment cover
(1 for DL72119)
(2 for DL72219)
(3 for DL72319)
(4 for DL72419)
(5 for DL72519/
DL72539/DL72549)



Telephone line cord



Wall-mount bracket

Important safety information



This symbol is to alert you to important operating or servicing instructions that may appear in this user's manual. Always follow basic safety precautions when using this product to reduce the risk of injury, fire, or electric shock.

Safety information

- ▶ Read and understand all instructions in the user's manual. Observe all markings on the product.
- ▶ Avoid using a telephone during a thunderstorm. There might be a slight chance of electric shock from lightning.
- ▶ Do not use a telephone in the vicinity of a gas leak. Under certain circumstances, a spark may be created when the adapter is plugged into the power outlet, or when the handset is replaced in its cradle. This is a common event associated with the closing of any electrical circuit. In an inadequately ventilated environment, the user should not plug the phone into a power outlet, nor put a charged handset into the cradle where there are concentrations of flammable or flame-supporting gases. A spark in such an environment could create a fire or explosion. Such environments might include: medical use of oxygen without adequate ventilation; industrial gases (cleaning solvents; gasoline vapors; etc.); a leak of natural gas; etc.
- ▶ Do not use this product near water or when you are wet. For example, do not use it in a wet basement or shower, nor next to a swimming pool, bathtub, kitchen sink, and laundry tub. Do not use liquids or aerosol sprays for cleaning. If the product comes in contact with any liquids, unplug any line or power cord immediately. Do not plug the product back in until it has dried thoroughly.
- ▶ Install this product in a protected location where no one can trip over any line or power cords. Protect cords from damage or abrasion.
- ▶ If this product does not operate normally, see the **Troubleshooting** section of the online Complete user's manual. If you cannot solve the problem, or if the product is damaged, refer to the **Limited warranty** section on pages 32 - 34. Do not open this product except as may be directed in your user's manual. Opening the product or reassembling it incorrectly may expose you to hazardous voltages or other risks.
- ▶ Replace batteries only as described in your user's manual (page 5). Do not burn or puncture batteries — they contain caustic chemicals.
- ▶ The power adapters are intended to be correctly oriented in a vertical or floor mount position. The prongs are not designed to hold the plug in place if it is plugged into a ceiling, under-the-table or cabinet outlet.
- ▶ For pluggable equipment, the socket-outlet shall be installed near the equipment and shall be easily accessible.

Important safety information



CAUTIONS:

- ▶ Use only the power adapter provided with this product. To obtain a replacement, visit our website at **<https://telephones.att.com>** or call **1 (800) 222-3111**. In Canada, dial **1 (866) 288-4268**.
- ▶ Use only the supplied rechargeable battery or replacement battery (model BT162342/ BT262342). To order, visit our website at **<https://telephones.att.com>**, or call **1 (800) 222-3111**. In Canada, dial **1 (866) 288-4268**.



CAUTION: To prevent risk of fire or battery explosion, replace with the correct battery type. Dispose of used batteries according to the instructions.

Especially about cordless telephones

- ▶ **Privacy:** The same features that make a cordless telephone convenient create some limitations. Telephone calls are transmitted between the telephone base and the handset by radio waves, so there is a possibility that your cordless telephone conversations could be intercepted by radio receiving equipment within range of the cordless handset. For this reason, you should not think of cordless telephone conversations as being as private as those on corded telephones.
- ▶ **Electrical power:** The telephone base of this cordless telephone must be connected to a working electrical outlet which is not controlled by a wall switch. Calls cannot be made from the handset if the telephone base is unplugged, switched off or if the electrical power is interrupted.
- ▶ **Potential TV interference:** Some cordless telephones operate at frequencies that may cause interference to TVs and VCRs. To minimize or prevent such interference, do not place the telephone base of the cordless telephone near or on top of a TV or VCR. If interference is experienced, moving the cordless telephone farther away from the TV or VCR will often reduce or eliminate the interference.
- ▶ **Rechargeable batteries:** This product contains nickel-metal hydride rechargeable batteries. Exercise care in handling batteries in order not to create a short circuit with conductive material such as rings, bracelets, and keys. The battery or conductor may overheat and cause harm. Observe proper polarity between the battery and the battery charger.
- ▶ **Nickel-metal hydride rechargeable batteries:** Dispose of these batteries in a safe manner. Do not burn or puncture. Like other batteries of this type, if burned or punctured, they could release caustic material which could cause injury.

Important safety information



The RBRC Seal means that the manufacturer is voluntarily participating in an industry program to collect and recycle nickel-metal hydride rechargeable batteries when taken out of service within the United States. These batteries may be taken to a participating local retailer of replacement batteries or recycling center. You may call 1-800-8-BATTERY® for locations accepting spent Ni-MH batteries. The RBRC Seal and 1-800-8-BATTERY® are registered trademarks of Call2recycle, Inc.

Precautions for users of implanted cardiac pacemakers

Cardiac pacemakers (applies only to digital cordless telephones):

Wireless Technology Research, LLC (WTR), an independent research entity, led a multidisciplinary evaluation of the interference between portable wireless telephones and implanted cardiac pacemakers. Supported by the U.S. Food and Drug Administration, WTR recommends to physicians that:

Pacemaker patients:

- ▶ Should keep wireless telephones at least six inches from the pacemaker.
- ▶ Should NOT place wireless telephones directly over the pacemaker, such as in a breast pocket, when it is turned ON.
- ▶ Should use the wireless telephone at the ear opposite the pacemaker.

WTR's evaluation did not identify any risk to bystanders with pacemakers from other persons using wireless telephones.

ECO mode

This power conserving technology reduces power consumption for optimal battery performance. The ECO mode activates automatically whenever the handset is synchronized with the telephone base.

Especially about telephone answering systems

Two-way recording: This unit does not sound warning beeps to inform the other party that the call is being recorded. To ensure that you are in compliance with any federal or state regulations regarding recording a telephone call, you should start the recording process and then inform the other party that you are recording the conversation.

SAVE THESE INSTRUCTIONS



Install

Telephone base

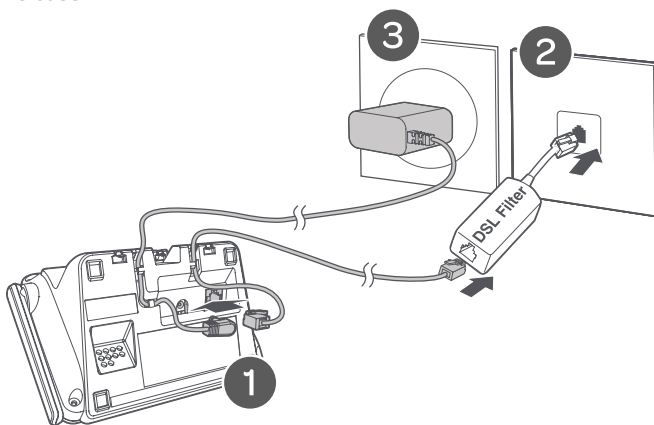

Notes:

- ▶ Plug one end of the telephone line cord into a telephone jack or a DSL filter.
- ▶ If you have DSL high-speed Internet service, a DSL filter (not included) is required.

Charger

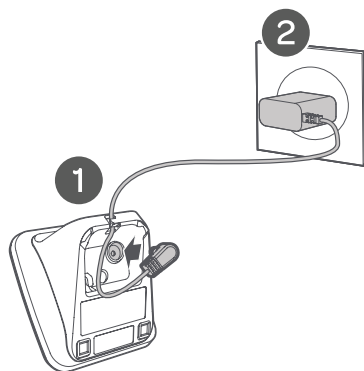

Caution: Use only the power adapter(s) provided with this product. To obtain a replacement, visit our website at

<https://telephones.att.com>

or call **1 (800) 222-3111**. In Canada, dial **1 (866) 288-4268**.



Install

Battery

Install the battery, as shown below.

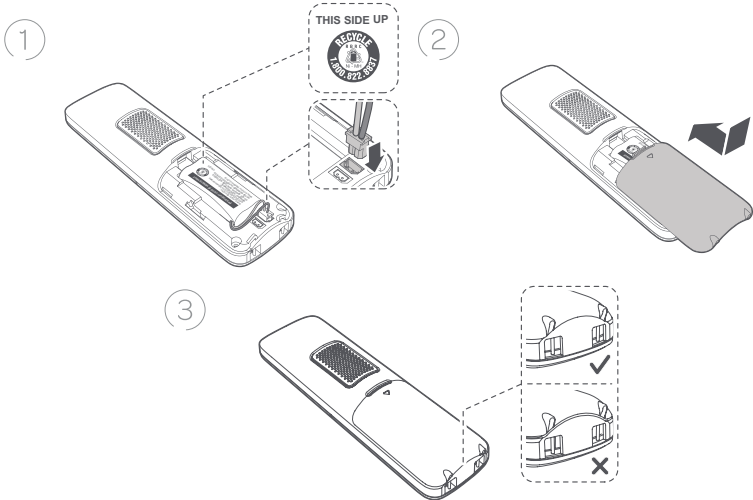

Charge your handset(s) before initial use. The battery is fully charged after 16 hours of continuous charging. The **CHARGE** light on the top of the handset is on during charging.

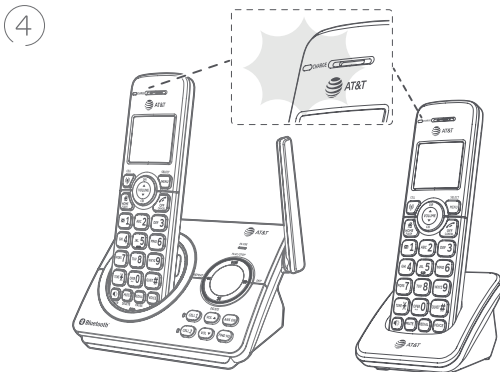

Caution: Use only the supplied rechargeable battery or replacement battery (model BT162342/BT262342).



Handset overview

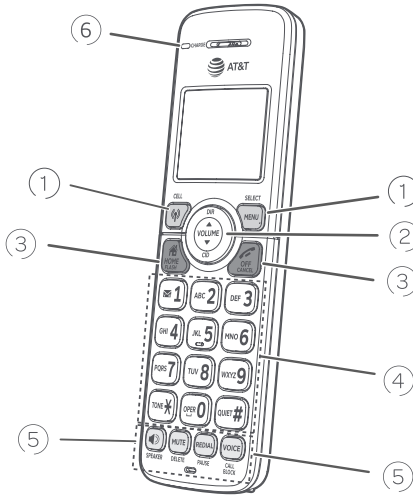





Handset

- | | |
|----------------------------------|---|
| <p>① CELL</p> | <ul style="list-style-type: none"> ▶ Press to make or answer a cell call. ▶ During a call, press to answer an incoming cell call when you hear a call waiting alert. |
| <p>MENU/
SELECT</p> | <ul style="list-style-type: none"> ▶ Press to display the menu. ▶ Once in the menu, press to select an item or save an entry or setting. |
| <p>② ▲DIR/
VOLUME</p> | <ul style="list-style-type: none"> ▶ Press to show directory entries when the telephone is not in use. ▶ Press to scroll up while in a menu. ▶ Press to increase the listening volume when on a call, or increase the message playback volume. ▶ While entering names or numbers, press to move the cursor to the right. |
| <p>▼CID/
VOLUME</p> | <ul style="list-style-type: none"> ▶ Press to review the caller ID log when the telephone is not in use. ▶ Press to scroll down while in a menu. ▶ Press to decrease the listening volume when on a call, or decrease the message playback volume. ▶ While entering names or numbers, press to move the cursor to the left. |



Handset overview

- ③
-  **HOME/
FLASH**
- ▶ Press to make or answer a home call.
 - ▶ During a call, press to answer an incoming home call when you receive a call waiting alert.
-  **OFF/
CANCEL**
- ▶ During a call, press to hang up.
 - ▶ While in a menu, press to cancel an operation, back up to the previous menu, or exit the menu display; or press and hold this button to exit to idle mode.
 - ▶ When the handset is ringing, press to mute the ringer temporarily.
 - ▶ Press and hold while the handset is not in use to erase the missed call indicator.
-
- ④
-  1
- TONEX**
- ▶ While reviewing a caller ID log entry, press repeatedly to add or remove 1 in front of the telephone number before dialing or saving it in the directory.
 - ▶ Press and hold to set or dial your voicemail number.
- QUIET #**
- ▶ Press to switch to tone dialing temporarily during a call if you have pulse service.
 - ▶ Press and hold to set and turn on the **QUIET** mode, or turn it off.
 - ▶ When reviewing a caller ID log entry, press repeatedly to view other dialing options.
-
- ⑤
-  **SPEAKER**
- ▶ Press to make or answer a call using the speakerphone.
 - ▶ Press to turn on the handset speakerphone, press again to resume normal handset use.
- MUTE/
DELETE**
- ▶ During a call, press to mute the microphone.
 - ▶ When the handset is ringing, press to mute the ringer temporarily.
 - ▶ While reviewing the redial list, directory, caller ID log, allow list, block list, or the star name list, press to delete an individual entry.
 - ▶ While predialing, press to delete digits.
 - ▶ When entering names or numbers, press to delete a digit or character.
 - ▶ When entering names or numbers, press and hold to erase all digits or characters.
 - ▶ During message or announcement playback, press to delete the playing message or the recorded announcement.
-



Handset / Telephone base overview

- 5 **REDIAL/
PAUSE**
- ▶ Press repeatedly to view the last 10 numbers dialed.
 - ▶ While entering numbers, press and hold to insert a dialing pause.
- VOICE/
CALL
BLOCK**
- ▶ While connected to one or two cell phones, press to activate the voice-controlled application of one of the connected cell phones.
 - ▶ When the telephone is ringing, press to block the incoming home call or cell call.
 - ▶ When on a home call or cell call, press to block the call.
-
- 6 **CHARGE
light**
- ▶ On when the handset is charging in the telephone base or charger.

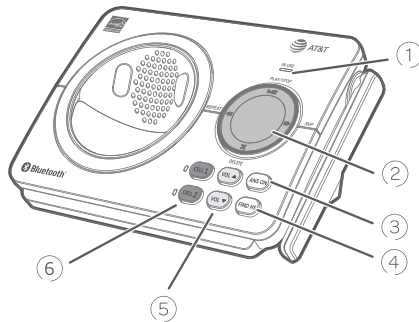

Telephone base

- 1 **IN USE light**
- ▶ On when the handset is in use, or when the answering system is answering an incoming call.
 - ▶ Flashes when there is an incoming call, or another telephone sharing the same line is in use.
-
- 2 **◀ REPEAT**
- ▶ Press to repeat a message.
 - ▶ Press twice to play the previous message.
- X/DELETE**
- ▶ Press to delete the message currently playing.
 - ▶ Press twice to delete all old messages when the telephone is not in use.
- ▶▶ SKIP**
- ▶ Press to skip a message.
- ▶/■ PLAY/
STOP**
- ▶ Press to start or stop message playback.
 - ▶ During call screening, press to temporarily turn the call screening on or off.



Telephone base overview

- | | | |
|-------|------------------------|--|
| ② | Message window | › Displays the number of messages or other answering system information. |
| <hr/> | | |
| ③ | ANS ON | › Press to turn the built-in answering system on or off. |
| <hr/> | | |
| ④ | FIND HS | › Press to page all handsets. |
| <hr/> | | |
| ⑤ | VOL ▲ | › When the telephone is idle, press to increase the telephone base ringer volume.

› During call screening or message playback, press to increase the listening volume. |
| | VOL ▼ | › When the telephone is idle, press to decrease the telephone base ringer volume.

› During call screening or message playback, press to decrease the listening volume. |
| <hr/> | | |
| ⑥ | CELL 1 / CELL 2 | › Light on when the telephone base is paired and connected with a Bluetooth device.

› Light flashes when the telephone base is in discoverable mode.

› Press to connect the paired cell Bluetooth device.

› <u>Press and hold</u> to add or replace a Bluetooth device. |
-



Initial basic settings

After you install your telephone or power returns following a power outage, the handset and telephone base will prompt you to set the date and time. To skip setting the date and time, press **OFF/CANCEL** on the handset.

Voice guide to set Smart call blocker and answering system

After the date and time setting is done or skipped, the telephone base will prompt if you want to set Smart call blocker. Press **MENU/SELECT** to start the Smart call blocker setup via voice guide. To skip the setup, press **OFF/CANCEL**.

After the Smart call blocker setting is done or skipped, the telephone base will then prompt if you want to set up the answering system. Press **MENU/SELECT** to start the answering system setup via voice guide. To skip the setup, press **OFF/CANCEL**.

We recommend you program your telephone system before use. The following are a few examples of common features to set before using the telephone. Refer to the **Handset and telephone base settings** and **Answering system settings** in the Complete user's manual for detailed instructions on setting all telephone features.

Date and time



Note: Set the date/time before using the answering system.

1. **MENU** -> ▼ or ▲ -> **Set date/time** -> **SELECT**.
2. Enter the month (**MM**), day (**DD**) and year (**YY**) -> **SELECT**.
3. Enter the hour (**HH**) and minute (**MM**).
4. ▼ or ▲ -> **AM** or **PM** -> **SELECT**.

Smart call blocker setup via voice guide

You can follow the voice guide to set up Smart call blocker.

1. **MENU** -> ▼ or ▲ -> **Smart call blk**.
2. ▼ or ▲ -> **Voice guide** -> **SELECT**.
3. Press **1** if you want to screen home calls with telephone numbers that are not saved in your Directory, Allow list, or Star name list; or Press **2** if you do not want to screen calls, and want to allow all incoming calls to get through.



Initial basic settings

Basic answering system setup via voice guide

You can follow the voice guide to record your own announcement, set the number of rings and set the message alert tone.

1. **MENU.**
2. ▼ or ▲ -> **Answering sys** -> **SELECT.**
3. ▼ or ▲ -> **Voice guide** -> **SELECT.**
4. Set up the answering system by inputting the designated numbers, as instructed.

Add a Bluetooth® cell phone/headset



Note: Your **DL72119/DL72219/DL72319/DL72419/DL72519/DL72539/DL72549** is compatible with Bluetooth version 2.0 or above devices.

To use a Bluetooth enabled cellular phone or headset with your telephone, you must first pair and connect your Bluetooth cellular phone or headset with the telephone base.

Bluetooth wireless technology operates within a short range (up to 30 feet). Keep the connected device within 15 feet of the telephone base for optimal performance.

To pair and connect a cell phone using the telephone base:

1. Press and hold **CELL 1** or **CELL 2**.
2. Place the cell phone next to the telephone base. Turn on the Bluetooth feature of your cell phone and search for or add new devices. Once your cell phone finds your AT&T phone (**AT&T DL72x19**), press the appropriate key on your cell phone to continue the pairing process.

To pair and connect a headset using the handset:

1. **MENU** -> ▼ or ▲ -> **Bluetooth** -> **SELECT.**
2. ▼ or ▲ -> **Add BT headset** -> **SELECT.**
3. Set your headset to discoverable mode -> Press **SELECT.**



Initial basic settings

Record your own announcement

Your outgoing announcement plays when calls are answered by the answering system. You can use the preset announcement to answer calls, or replace it with your own recorded announcement.

Using a cordless handset:

1. **MENU** -> ▼ or ▲ -> **Answering sys** -> **SELECT**.
2. **SELECT** to select **Announcement**.
3. Press **7** to record.
4. Speak towards the handset to record your announcement and press **5** to end recording and save it.

Number of rings

You can set the answering system to answer an incoming call after 2, 3, 4, 5, or 6 rings. You can also select toll saver. If you choose toll saver, the answering system answers a call after two rings when you have new messages, or after four rings when there are no new messages. This enables you to check for new messages and avoid paying unnecessary long distance charges if you are calling from out of your local area.

Using a cordless handset:

1. **MENU** -> ▼ or ▲ -> **Answering sys** -> **SELECT**.
2. ▼ or ▲ -> **Ans sys setup** -> **SELECT**.
3. ▼ or ▲ -> **# of rings** -> **SELECT**.
4. ▼ or ▲ to choose among **2, 3, 4, 5, 6**, or **Toll saver** -> **SELECT**.

Ringer volume

You can set the ringer volume level to one of the six levels, or turn the ringer off, for incoming home or cell calls.

Using a cordless handset:

Set ringer volume for incoming home calls:

1. **MENU** -> ▼ or ▲ -> **Ringers** -> **SELECT**.
2. **SELECT** to select **Home volume**.
3. ▼ or ▲ to choose the desire level -> **SELECT**.

Set ringer volume for incoming cell calls:

1. **MENU** -> ▼ or ▲ -> **Ringers** -> **SELECT**.
2. ▼ or ▲ to select **Cell volume** -> **SELECT**.
3. ▼ or ▲ to choose the desire level -> **SELECT**.



Initial basic settings

LCD language

Using a cordless handset:

1. **MENU** -> ▼ or ▲ -> **Settings** -> **SELECT**.
2. **SELECT** again to select **LCD language**.
3. ▼ or ▲ to choose **English, Français** or **Español** -> **SELECT**.



Note: If you accidentally change the LCD language to French or Spanish, you can reset it back to English without going through the French or Spanish menus.

- ▶ Press **MENU/SELECT** on the handset in idle mode -> enter ***364#**.



Operate

Operation	Steps
Making a home or cell call	<p>Using a cordless handset:</p> <ul style="list-style-type: none"> ▶ Press HOME/FLASH or /SPEAKER -> Enter the telephone number. ▶ Press /CELL -> Enter the telephone number -> MENU/SELECT.
On-hook dialing (predialing)	<p>Using a cordless handset:</p> <p>Enter the telephone number -> Press HOME/FLASH, /CELL or /SPEAKER to call.</p>
Answering a home or cell call	<p>Using a cordless handset:</p> <p>Press HOME/FLASH, /CELL or /SPEAKER, or press any dialing keys (0-9, TONE or QUIET#).</p>
Ending a call	<p>Using a cordless handset:</p> <p>Press OFF/CANCEL or return the handset to the telephone base or charger.</p>
Handset speakerphone	<p>During a call, press /SPEAKER to switch between handsfree speakerphone and normal handset use.</p>



Operate

Operation	Steps
Redial	<p>Using a cordless handset:</p> <ol style="list-style-type: none">1. Press REDIAL.2. Press ▼, ▲ or REDIAL repeatedly to select the desired entry -> HOME/FLASH, CELL or SPEAKER to call.
Volume control	<p>Using a cordless handset: Press ▼/VOLUME/▲ on the handset while on a call.</p> <p>Using the telephone base: Press VOL ▼ or VOL ▲ while listening to the message playback on the telephone base.</p>
Call waiting (Requires subscription from telephone)	<ul style="list-style-type: none">▶ Press HOME/FLASH on the handset to put your current call on hold and take the new home call.▶ Press CELL on the handset to put your current call on hold and take the new cell call.



Directory

The directory can store up to 1,000 entries, which are shared by all system devices.

Operation	Steps
Adding an entry in the directory	<p>Using a cordless handset:</p> <ol style="list-style-type: none">1. MENU -> ▼ or ▲ -> Directory -> SELECT.2. SELECT to select Add new entry.3. Enter a telephone number up to 30 digits -> SELECT.4. Enter a name up to 15 characters -> SELECT.
Searching/dialing an entry	<ol style="list-style-type: none">1. Press DIR on the handset in idle mode -> ▼ or ▲ to select the desired directory.2. Press HOME/FLASH or SPEAKER on the handset to call using the home line. -OR- Press CELL on the handset to call using the cell line.

Download a cell phone directory

To download a cell phone directory using the handset:

Before downloading a directory, make sure the cell phone is paired, active, and connected to your **DL72119/DL72219/DL72319/DL72419/DL72519/DL72539/DL72549**.

1. **MENU** -> ▼ or ▲ -> **Bluetooth** -> **SELECT**.
2. ▼ or ▲ -> **Download DIR** -> **SELECT**.
3. ▼ or ▲ to choose a desired device when necessary -> **SELECT**.



Connect to Cell™ app

If you are using Bluetooth-enabled cell phones with Android® OS 2.3 or above, you may also download the **Connect to Cell™** application (consists of **Caller ID manager** and **Alerts manager**) using the Google Play® Store app to extend the flexibility of your **DL72119/DL72219/DL72319/DL72419/DL72519/DL72539/DL72549**. Scan the QR code on the right to download the application.



Remote voice control

If you have connected a cell phone to the telephone system, you can activate the voice-controlled application (voice app) of the cell phone, such as Siri®, Google Now™ or S Voice®, using the handset or telephone base.

Compatibility:

The remote voice control feature works with:

Voice-controlled application	Siri	Google Now	S Voice
Operation System (Versions supported)	iOS (8 or above)	Android (4 or above)	Android (4 or above)

Before using the remote voice control feature, make sure you checked the following:

- ▶ Your cell phone is paired and connected to your telephone system via Bluetooth.
- ▶ No Bluetooth applications are running in the background of your cell phone.
- ▶ Keep your cell phone within 15 feet of the telephone base.
- ▶ Do not lock up your cell phone's screen or set passcode for activating the voice app.
- ▶ Make sure you have turned on or logged in to the applications on your cell phone that you will be sending your voice commands, such as GPS, e-mail and social networking accounts.
- ▶ Your cell phone's data or Wi-Fi signal is in full strength and your cell phone can connect to the Internet.
- ▶ Try to activate the voice app on your cell phone to ensure it is in place.

Android® and Google Play® are registered trademarks of Google Inc.

Connect to Cell™ is a trademark of Advanced American Telephones.

Siri® is a registered trademark of Apple Inc.

Google Now™ is a trademark of Google Inc.

S Voice® is a registered mark of Samsung Electronics Co., Ltd.

iOS is a trademark or registered trademark of Cisco in the U.S. and other countries and is used under license.



To activate remote voice control:



1. Press **VOICE/CALL BLOCK**.
-OR-
If you have two connected cell phones -> ▼ or ▲ to select a device.
2. When the telephone base or handset plays the confirmation tone, speak toward the telephone base or handset, and then wait for feedback. Make reply to the voice app's feedback, if necessary.
3. Press  **OFF/CANCEL** to exit.

Refer to the online Complete user's manual for a list of troubleshooting tips on using Remote voice control feature.



This product supports caller ID services offered by most telephone service providers. The telephone stores caller ID information of the last 50 incoming calls in the telephone base. This information is common to all devices.

Review and dial a number in the call log

1. Press **CID** on the handset in idle mode -> ▼ or ▲ to scroll through the list.
2. Press  **HOME/FLASH OR /SPEAKER** on the handset to dial with the home line.
-OR-
Press  **CELL** on the handset to dial with the cell line.

Erase missed calls indicator in the call log

When the screen shows **XX Missed calls**, scroll the call log one by one, or press and hold  **OFF/CANCEL** on the handset in idle mode.



Smart call blocker *

If you have subscribed to caller ID service, then you can use the Smart call blocker feature to screen incoming calls.



Note: The screening feature of Smart call blocker is applicable to incoming home calls only. All incoming cell calls will get through and ring. If you want to block a cell call, add the number to the block list.

Turn Smart call blocker on or off

Smart call blocker is set to on, and to allow all incoming calls by default. To turn on or off Smart call blocker:

1. **MENU** -> ▼ or ▲ -> **Smart call blk** -> **SELECT**.
2. **SELECT** to choose **SCB On/Off**.
3. ▼ or ▲ to choose **On** or **Off** -> **SELECT**.



Notes:

- ▶ Smart call blocker is on, once you install your telephone. It allows all incoming calls to get through and ring by default. You can change the Smart call blocker settings to screen incoming home calls from numbers or names that are not yet saved in your directory, allow list, block list, or star name list. You can easily add incoming phone numbers to your allow list and block list. This allows you to build up your lists of allowed and blocked numbers, and Smart call blocker will know how to deal with these calls when they come in again.
- ▶ If you turn off Smart call blocker, all incoming calls will ring, including numbers saved in your block list.
- ▶ When QUIET mode is on, and Smart call blocker is on and in screening mode, all screened home calls will be sent to the answering system after screening.

Call controls

Call categories		Call control and options
Unwelcome calls	<ul style="list-style-type: none"> ▶ Numbers saved in block list. 	The telephone blocks these calls from ringing through.
Welcome calls	<ul style="list-style-type: none"> ▶ Numbers saved in allow list. ▶ Numbers saved in directory. ▶ Numbers not found in block list. ▶ Caller ID names saved in star name list. 	The telephone allows these calls to get through and ring.  Note: All incoming cell calls will get through and ring by default. If you want to block a cell call, add the number to the block list.



Smart call blocker

Call categories		Call control and options
Unknown calls (for home calls only)	<ul style="list-style-type: none">▸ Calls without numbers<ul style="list-style-type: none">– Numbers that are “out of area” or set to “Private”.	<p>You can select one of the following five profile options for handling all unknown home calls.</p> <p>Screen unknown The telephone plays the screening announcement, and then ask the caller to say his/her name before the call rings on your telephone. You can then answer the call, and hear the caller’s name announced. You can decide whether to accept or reject the call, or to forward the call to the answering system.</p> <p>Screen robot The telephone plays the screening announcement, and then ask the caller to press the pound key (#) before the call rings on your telephone. You can then answer the call.</p> <p>Allow unknown (default settings) The telephone allows these calls to get through and ring. The caller’s number, even if it is available, will not be saved to the allow list.</p> <p>Unknown to answering system The telephone forwards these calls to the answering system without ringing.</p> <p>Block unknown The telephone rejects these calls with block announcement without ringing. The caller’s number, even if it’s available, will not be saved to the block list.</p>
	<ul style="list-style-type: none">▸ Uncategorized calls<ul style="list-style-type: none">– With absent caller ID number.– Numbers not found in directory.– Numbers not found in allow list.– Numbers not found in block list.– With caller ID names not found in star name list	

* Includes licenced Qalitel™ technology.
Qalitel™ is a trademark of Truecall Group Limited.



Smart call blocker

Set up allow list, block list and star name list

Add numbers from caller ID log

Adding CID log entry to block list	<ol style="list-style-type: none">1. Press CID on the handset -> ▼ or ▲ .2. Press SELECT when the desired entry appears.3. ▼ or ▲ -> To Block list -> SELECT.4. Press SELECT twice.
Adding CID log entry to allow list	<ol style="list-style-type: none">1. Press CID on the handset -> ▼ or ▲ .2. Press SELECT when the desired entry appears.3. ▼ or ▲ -> To Allow list -> SELECT.4. Press SELECT twice.
Adding CID log entry to star name list	<ol style="list-style-type: none">1. Press CID on the handset -> ▼ or ▲ .2. Press SELECT when the desired entry appears.3. ▼ or ▲ -> To Star name -> SELECT.4. Press SELECT twice.

Add numbers manually

Adding a new number to the block list	<ol style="list-style-type: none">1. MENU -> ▼ or ▲ -> Smart call blk -> SELECT.2. ▼ or ▲ -> Block list -> SELECT.3. ▼ or ▲ -> Add new entry -> SELECT.4. Enter a telephone number up to 30 digits -> SELECT.5. Enter a name up to 15 characters -> SELECT.
Adding a new number to the allow list	<ol style="list-style-type: none">1. MENU -> ▼ or ▲ -> Smart call blk -> SELECT.2. ▼ or ▲ -> Allow list -> SELECT.3. ▼ or ▲ -> Add new entry -> SELECT.4. Enter a telephone number up to 30 digits -> SELECT.5. Enter a name up to 15 characters -> SELECT.



Smart call blocker

Adding a new name to the star name list	<ol style="list-style-type: none">1. MENU -> ▼ or ▲ -> Smart call blk -> SELECT.2. ▼ or ▲ -> Star name list -> SELECT.3. ▼ or ▲ -> Add new entry -> SELECT.4. Enter a name up to 15 characters -> SELECT.
---	--

Set profile

There are five profile setting options, which allows you to quickly set up Smart call blocker.

Set profile	Steps
Screen unknown Screen all unknown home calls	<ol style="list-style-type: none">1. MENU -> ▼ or ▲ -> Smart call blk -> SELECT.2. ▼ or ▲ -> Set profile -> SELECT.3. ▼ or ▲ -> Screen unknown -> SELECT.
Screen robot Screen robocalls	<ol style="list-style-type: none">1. MENU -> ▼ or ▲ -> Smart call blk -> SELECT.2. ▼ or ▲ -> Set profile -> SELECT.3. ▼ or ▲ -> Screen robot -> SELECT.
Allow unknown Block calls on the block list only (default settings)	<ol style="list-style-type: none">1. MENU -> ▼ or ▲ -> Smart call blk -> SELECT.2. ▼ or ▲ -> Set profile -> SELECT.3. ▼ or ▲ -> Allow unknown -> SELECT.
UnknownToAns.S Forward all unknown home calls to the answering system	<ol style="list-style-type: none">1. MENU -> ▼ or ▲ -> Smart call blk -> SELECT.2. ▼ or ▲ -> Set profile -> SELECT.3. ▼ or ▲ -> UnknownToAns.S -> SELECT.
Block unknown Block all unknown home calls	<ol style="list-style-type: none">1. MENU -> ▼ or ▲ -> Smart call blk -> SELECT.2. ▼ or ▲ -> Set profile -> SELECT.3. ▼ or ▲ -> Block unknown -> SELECT.



Smart call blocker

Add a screened number to the block list or allow list

If you select **Screen unknown** or **Screen robot** in **Set profile**, the telephone plays a screening announcement to the caller, and asks the caller to respond before the call rings through to you. After the caller responds, the telephone rings and you can then pick up the call. The telephone then asks whether you want to answer or reject the call, or to forward the call to the answering system. The telephone announces *“To answer the call, press 1. To answer and always allow this number, press 2. To block this number, press 3. To send this call to the answering system, press 4. To repeat these options, press *”*.

You can add a screened number to the block list or to the allow list.

Add current number to the allow list	▶ Press 2 to answer the home call, and add the current number to the allow list.
Add current number to the block list	▶ Press 3 to block the home call, and add the current number to the block list.



Notes

- ▶ The screening feature of Smart call blocker is applicable to home calls only. All incoming cell calls will get through and ring.
- ▶ Unknown home calls without caller ID information will not have the option 2, “answer and always allow this number”, and option 3, “to block this number”. No number will be added to the allow list or block list for these calls.
- ▶ If you do not want to take the call, press  **OFF/CANCEL** to end the call.

Block the caller while on a call

When you are on a home or cell call and speaking to the caller, and you do not want to continue the call, you can end the call with block announcement and add the number to the block list.

1. During a home or cell call, press **VOICE/CALL BLOCK**.
2. Press **SELECT** to end the call.



Notes

- ▶ The allow list stores up to 200 entries, the block list stores up to 1,000 entries, and the star name list stores up to 10 names.
- ▶ There are many organizations like schools, medical offices, and pharmacies that use robocalls to communicate important information to you. Robocall uses an autodialer to deliver pre-recorded messages. By entering the name of the organizations into the star name list, it ensures these calls will ring through when you only know the caller names but not their numbers.

Unblock a telephone number



If you have added a telephone number to the block list, you can unblock it.

1. **MENU** -> ▼ or ▲ -> **Smart call blk** -> **SELECT**.
2. ▼ or ▲ -> **Block list** -> **SELECT**.
3. Press **SELECT** to select **Review**.
4. ▼ or ▲ to browse through the block entries.
5. When the desired entry displays, press **DELETE**, then press **SELECT** to confirm.

Answering system

About answering system and voicemail

Your telephone has separate indicators for two different types of voice messages: those left on the built-in answering system and those left at your telephone service provider's voicemail. To listen to messages recorded on the built-in answering system, refer to the **Message playback** section; to listen to voicemail, contact your telephone service provider for more information.

	Built-in answering system ▶/■	Voicemail service ✉
Supported by	Telephone system	Telephone service provider
Subscription	No	Yes
Fees	No	May apply
Answer incoming calls	<ul style="list-style-type: none">▶ After 3 rings by default.▶ It can be changed in the handset or the telephone base menu.	<ul style="list-style-type: none">▶ Usually after 2 rings.▶ It can be changed by contacting your telephone service provider.
Storage	Telephone base	Server or System
Display new messages	<ul style="list-style-type: none">▶ Handset and telephone base - XX New messages	<ul style="list-style-type: none">▶ Handset and telephone base -  and New voicemail
Retrieve messages	<ul style="list-style-type: none">▶ Press ▶/■ on the telephone base; OR▶ Press MENU, and then select Play messages on the handset; OR▶ Access remotely with an access code.	<ul style="list-style-type: none">▶ Press  on the dialpad, and enter an access number from your telephone service provider.

Answering system

Turn answering system on or off

The answering system must be turned on to answer and record messages.

Using a cordless handset:

1. **MENU** -> ▼ or ▲ -> **Answering sys** -> **SELECT**.
2. ▼ or ▲ -> **Answer on/off** -> **SELECT**.
3. ▼ or ▲ to choose **On** or **Off**-> **SELECT**.

Using the telephone base:

- ▶ Press **ANS ON** to turn the answering system on or off. If the answering system is turned on, it announces, *"Calls will be answered."* If the answering system is turned off, it announces, *"Calls will not be answered."*

Message alert tone

When this feature is on, and there is at least one new message, the telephone base beeps every 10 seconds.

Using a cordless handset:

1. **MENU** -> ▼ or ▲ -> **Answering sys** -> **SELECT**.
2. ▼ or ▲ -> **Ans sys setup** -> **SELECT**.
3. ▼ or ▲ -> **Msg alert tone** -> **SELECT**.
4. ▼ or ▲ to choose **On** or **Off** -> **SELECT**.

Call screening

Use this feature to choose whether incoming messages can be heard over the speaker when they are being recorded. If you turn call screening on, you hear the incoming message.

Using a cordless handset:

1. **MENU** -> ▼ or ▲ -> **Answering sys** -> **SELECT**.
2. ▼ or ▲ -> **Ans sys setup** -> **SELECT**.
3. **SELECT** to select **Call screening**.
4. ▼ or ▲ to choose **On** or **Off** -> **SELECT**.

Answering system

Message playback

Using the telephone base:

- › Press **▶/■/PLAY/STOP** when the telephone base is in idle mode.

Using a cordless handset:

- › Press **MENU** then **SELECT** when the handset is in idle mode.

Options during playback

Feature	On the telephone base	On a handset
Adjust playback to volume	Press VOL ▼ or VOL ▲	Press ▼/VOLUME/▲
Stop playback	Press ▶/■/PLAY/STOP	Press ↵/OFF/CANCEL
Skip to the next message	Press ▶▶/SKIP	Press 6
Repeat the message	Press ◀◀/REPEAT	Press 4
Play the previous message	Press ◀◀/REPEAT twice	Press 4 twice
Delete the message	Press X/DELETE	Press 3 or MUTE/DELETE

For C-UL compliance

In compliance with the bilingual requirements for safety, caution, and warning markings of Canadian Federal and Provincial/Territorial statutes and regulations, the French version of Important safety information is included.

Mesures de sécurité importantes



Ce symbole vous alertera d'informations importantes ou d'instructions d'entretien pouvant apparaître dans ce guide d'utilisation. Respectez toujours les mesures de sécurité et de sécurité de base lorsque vous utilisez ce produit, afin de réduire les risques de blessures, d'incendie, ou d'électrocution.

Information relative à la sécurité

- ▶ Veuillez lire et comprendre toutes les instructions de ce guide d'utilisation. Relectez toutes les inscriptions apparaissant sur le produit.
- ▶ Évitez d'utiliser le téléphone pendant un orage. Il pourrait y avoir un faible risque d'électrocution.
- ▶ N'utilisez pas un téléphone près d'une fuite de gaz. Dans certaines circonstances, une flammèche pourrait se produire lorsque l'adaptateur est branché à une prise de courant, ou lorsque le combiné est déposé sur son chargeur. Ceci est un événement fréquent associé avec la fermeture d'un circuit électrique. L'utilisateur ne devrait pas brancher un téléphone dans une prise de courant, et ne devrait pas déposer un combiné chargé dans le chargeur, si le téléphone se trouve dans un environnement comportant une concentration de gaz inflammables ou ignifuges, à moins de se trouver dans un endroit où la ventilation est adéquate. Une flammèche dans de tels environnements pourrait provoquer une explosion. De tels environnements peuvent comprendre : les endroits où de l'oxygène à des fins médicales est utilisé sans ventilation adéquate; des endroits où se trouvent des gaz industriels (dissolvants de nettoyage, des vapeurs de gazoline, etc.), une fuite de gaz naturel, etc.
- ▶ N'utilisez pas ce produit près de l'eau ou lorsque vous êtes mouillés. Par exemple, ne l'utilisez pas dans des sous-sols humides ou sous la douche, ou près d'une piscine, d'un bain, d'un évier de cuisine, ou d'une cuve de lavage. N'utilisez pas de liquides, ou de vaporisateurs aérosol de nettoyage. Si le produit entre en contact avec du liquide, débranchez immédiatement le fil téléphonique ou le cordon d'alimentation. Ne rebranchez pas le produit avant qu'il soit complètement sec.
- ▶ Installez cet appareil dans un endroit protégé où personne ne peut trébucher sur les cordons d'alimentation ou la ligne téléphonique. Protégez les câbles contre les dommages ou l'abrasion.

For C-UL compliance

- ▶ Si le produit ne fonctionne pas correctement, consultez la section **Dépannage (Troubleshooting)** du guide d'utilisation. Si vous ne pouvez pas régler le problème, ou si le produit est endommagé, consultez la section **Garantie limitée (Limited warranty)** des pages 32-34. N'ouvrez pas ce produit, sauf tel qu'indiqué dans le guide d'utilisation. L'ouverture du produit ou le remontage inadéquat pourrait vous exposer à des tensions dangereuses ou autres dangers.
- ▶ Remplacez les piles uniquement tel que décrit dans votre guide d'utilisation (Page 5). N'incinerez pas et ne percez pas les piles — elles contiennent des produits chimiques caustiques.
- ▶ L'adaptateur de courant est conçu pour être orienté verticalement ou installé sur le plancher. Les broches ne sont pas conçues pour se maintenir en place si la fiche est branchée dans une prise de courant au plafond, sous la table ou sous une armoire.
- ▶ Pour les produits à brancher à une prise de courant, la prise de courant doit être installée près du produit, afin d'assurer une accessibilité sécuritaire à la prise de courant.



MISES EN GARDE:

- ▶ N'utilisez seulement l'adaptateur inclus avec ce produit. Pour obtenir une pièce de rechange, visitez notre site Web au

<https://telephones.att.com> ou composez le
1-800-222-3111. Au Canada, composez le **1-866-288-4268**.

- ▶ N'utilisez que la pile de rechargeable incluse ou une pile de rechange (modèle BT162342/BT262342). Pour commander, visitez notre site Web

<https://telephones.att.com> ou composez le
1-800-222-3111. Au Canada, composez le **1-866-288-4268**.



ATTENTION: Afin de prévenir les risques d'incendie ou d'explosion de la pile, remplacez la pile avec une pile du même type. Jetez les piles épuisées en respectant les instructions.

For C-UL compliance

Spécifiquement en rapport avec les téléphones sans fil

- ▶ Confidentialité : Les mêmes caractéristiques qui rendent les téléphones sans fil si pratiques créent également des restrictions. Les appels téléphoniques sont transmis entre le socle du téléphone et le combiné par le biais d'ondes radio, et il se peut que vos conversations téléphoniques soient interceptées par d'autres équipements de réception d'ondes radio au sein de la portée du téléphone sans fil. Pour cette raison, vous ne devez pas considérer les conversations sur un téléphone sans fil comme étant aussi confidentielles que celles d'un téléphone à cordon.
- ▶ Alimentation électrique : La base de ce téléphone sans fil doit être branchée à une prise de courant électrique fonctionnelle. La prise électrique ne doit pas être contrôlée par un interrupteur mural. Les appels ne peuvent pas être effectués à partir du combiné si la base n'est pas branchée, si elle est hors fonction ou si le courant électrique est coupé.
- ▶ Interférences potentielles aux téléviseurs : Certains téléphones sans fil fonctionnent sur des fréquences pouvant causer des interférences aux téléviseurs et magnétoscopes. Pour réduire ou prévenir de tels parasites, ne pas déposer la base du téléphone sans fil à proximité d'un téléviseur ou magnétoscope, ni directement sur celui-ci. Si votre téléviseur affiche des interférences, éloignez le téléphone sans fil de celui-ci afin de réduire les parasites.
- ▶ Piles rechargeables : Ce produit comporte des piles rechargeables à l'hydrure métallique de nickel. Utilisez de prudence lorsque vous manipulez de telles piles et veillez à ne pas les court-circuiter avec des matériaux conducteurs, tels que des bagues, bracelets et clés. La pile ou le conducteur peut surchauffer et vous brûler. Respectez la polarité adéquate entre les piles et le chargeur de piles.
- ▶ Piles rechargeables à l'hydrure métallique de nickel : Jetez ces piles de manière sécuritaire. N'incinerez pas et ne percez pas les piles. Comme pour les autres piles du même type, si elles sont brûlées ou percées, des matières corrosives peuvent s'en échapper, ce qui risque de causer des brûlures ou autres blessures corporelles.



Le sceau de l'organisme de recyclage RBRC Seal sur les piles à l'hydrure métallique de nickel signifie que le fabricant de cet appareil participe volontairement au programme industriel visant à reprendre et recycler ce type de piles lorsqu'elles ne servent plus, au sein du territoire des États-Unis et du Canada. Vous devez apporter ces piles chez un détaillant participant ou le centre de recyclage le plus près de chez vous. Ou vous pouvez composer le 1-800-8-BATTERY^{MD} afin de connaître les endroits qui acceptent les piles à l'hydrure métallique de nickel mortes.

Le sceau RBRC et 1-800-8-BATTERY^{MD} sont des marques déposées de Call2recycle, Inc.

For C-UL compliance

Mesures préventives pour les utilisateurs de stimulateurs cardiaques implantés dans l'organisme

Stimulateurs cardiaques (ne s'applique qu'aux téléphones sans fil numériques) :

L'organisme "Wireless Technology Research, LLC (WTR)", une firme de recherche indépendante, a mené une évaluation pluridisciplinaire des interférences entre les téléphones sans fil portatifs et les stimulateurs cardiaques implantés dans l'organisme. Appuyée par l'Administration des aliments et drogues (FDA) des États-Unis, la firme WTR recommande aux médecins :

Avis aux détenteurs de stimulateurs cardiaques:

- ▶ Ils doivent tenir le téléphone sans fil à une distance d'au moins six pouces du stimulateur cardiaque.
- ▶ Ils ne doivent PAS placer le téléphone sans fil directement sur le stimulateur cardiaque, tel que dans une poche de chemise, lorsque celui-ci est en fonction.
- ▶ Ils doivent utiliser le téléphone sans fil en l'appuyant sur l'oreille qui se trouve dans la direction opposée au stimulateur cardiaque.

L'étude effectuée par l'organisme WRS n'a pas identifié de risque pour les détenteurs de stimulateurs cardiaques causé par les gens qui utilisent un téléphone sans fil à proximité de ceux-ci.

Mode ECO

Lorsque le socle communique avec le combiné, le mode ECO sera activé automatiquement. Ceci réduit la consommation d'énergie selon la distance entre le socle du téléphone et le combiné.

Spécifiquement en rapport avec les répondeurs téléphoniques

Enregistrement deux voies : Cet appareil n'émet pas de bips d'avertissement qui permettent de prévenir l'autre partie que vous enregistrez la conversation. Pour assurer votre conformité aux règlements fédéraux ou provinciaux en rapport avec les enregistrements des conversations téléphoniques, vous devriez informer l'autre partie lorsque vous activez l'enregistrement.

CONSERVEZ CES INSTRUCTIONS

FCC Part 68 and ACTA

This equipment complies with Part 68 of the FCC rules and with technical requirements adopted by the Administrative Council for Terminal Attachments (ACTA). The label on the back or bottom of this equipment contains, among other things, a product identifier in the format US:AAAEQ##TXXXX. This identifier must be provided to your telephone service provider upon request.

The plug and jack used to connect this equipment to premises wiring and the telephone network must comply with the applicable Part 68 rules and technical requirements adopted by ACTA. A compliant telephone cord and modular plug is provided with this product. It is designed to be connected to a compatible modular jack that is also compliant. An RJ11 jack should normally be used for connecting to a single line and an RJ14 jack for two lines. See the installation instructions in the user's manual.

The Ringer Equivalence Number (REN) is used to determine how many devices you may connect to your telephone line and still have them ring when you are called. The REN for this product is encoded as the 6th and 7th characters following the US: in the product identifier (e.g., if ## is 03, the REN is 0.3). In most, but not all areas, the sum of all RENs should be five (5.0) or less. For more information, please contact your telephone service provider.

This equipment must not be used with Party Lines. If you have specially wired alarm dialing equipment connected to your telephone line, ensure the connection of this equipment does not disable your alarm equipment. If you have questions about what will disable the alarm equipment, consult your telephone service provider or a qualified installer.

If this equipment is malfunctioning, it must be unplugged from the modular jack until the problem has been corrected. Repairs to this telephone equipment can only be made by the manufacturer or its authorized agents. For repair procedures, follow the instructions outlined under the Limited warranty.

If this equipment is causing harm to the telephone network, the telephone service provider may temporarily discontinue your telephone service. The telephone service provider is required to notify you before interrupting service. If advance notice is not practical, you will be notified as soon as possible. You will be given the opportunity to correct the problem and the telephone service provider is required to inform you of your right to file a complaint with the FCC. Your telephone service provider may make changes in its facilities, equipment, operation, or procedures that could affect the proper functioning of this product. The telephone service provider is required to notify you if such changes are planned.

If this product is equipped with a corded or cordless handset, it is hearing aid compatible.

If this product has memory dialing locations, you may choose to store emergency telephone numbers (e.g., police, fire, medical) in these locations. If you do store or test emergency numbers, please:

- ▶ Remain on the line and briefly explain the reason for the call before hanging up.
- ▶ Perform such activities in off-peak hours, such as early morning or late evening.

Industry Canada

This device contains licence-exempt transmitter(s)/receiver(s) that comply with Innovation, Science and Economic Development Canada's licence-exempt RSS(s). Operation is subject to the following two conditions:

- (1) This device may not cause interference.
- (2) This device must accept any interference, including interference that may cause undesired operation of the device.

Privacy of communications may not be ensured when using this telephone.

The term "IC:" before the certification/registration number only signifies that the Industry Canada technical specifications were met.

The Ringer Equivalence Number (REN) for this terminal equipment is 1.0. The REN indicates the maximum number of devices allowed to be connected to a telephone interface. The termination of an interface may consist of any combination of devices subject only to the requirement that the sum of the RENs of all the devices not exceed five.

This product meets the applicable Innovation, Science and Economic Development Canada technical specifications.

FCC Part 15

NOTE: This equipment has been tested and found to comply with the requirements for a Class B digital device under Part 15 of the Federal Communications Commission (FCC) rules. These requirements are intended to provide reasonable protection against harmful interference in a residential installation. This equipment generates, uses and can radiate radio frequency energy and, if not installed and used in accordance with the instructions, may cause harmful interference to radio communications. However, there is no guarantee that interference will not occur in a particular installation. If this equipment does cause harmful interference to radio or television reception, which can be determined by turning the equipment off and on, the user is encouraged to try to correct the interference by one or more of the following measures:

- ▶ Reorient or relocate the receiving antenna.
- ▶ Increase the separation between the equipment and receiver.
- ▶ Connect the equipment into an outlet on a circuit different from that to which the receiver is connected.
- ▶ Consult the dealer or an experienced radio/TV technician for help.

WARNING: Changes or modifications to this equipment not expressly approved by the party responsible for compliance could void the user's authority to operate the equipment.

This device complies with Part 15 of the FCC Rules. Operation is subject to the following two conditions: (1) this device may not cause harmful interference, and (2) this device must accept any interference received, including interference that may cause undesired operation. Privacy of communications may not be ensured when using this telephone.

To ensure safety of users, the FCC has established criteria for the amount of radio frequency energy that can be safely absorbed by a user or bystander according to the intended usage of the product. This product has been tested and found to comply with the FCC criteria. The handset may be safely held against the ear of the user. The telephone base shall be installed and used such that parts of the user's body other than the hands are maintained at a distance of approximately 20 cm (8 inches) or more.

This Class B digital apparatus complies with Canadian requirement:
CAN ICES-3 (B)/NMB-3(B)

Limited warranty

The AT&T brand is used under license - any repair, replacement or warranty service, and all questions about this product should be directed to our website at

<https://telephones.att.com> or call **1 (800) 222-3111**. In

Canada, dial **1 (866) 288-4268**.

1. What does this limited warranty cover?

The manufacturer of this AT&T branded product warrants to the holder of a valid proof of purchase ("CONSUMER" or "you") that the product and all accessories provided in the sales package ("PRODUCT") are free from defects in material and workmanship, pursuant to the following terms and conditions, when installed and used normally and in accordance with the PRODUCT operating instructions. This limited warranty extends only to the CONSUMER for products purchased and used in the United States of America and Canada.

2. What will be done if the PRODUCT is not free from defects in materials and workmanship during the limited warranty period ("materially defective PRODUCT")?

During the limited warranty period, the manufacturer's authorized service representative will repair or replace at the manufacturer's option, without charge, a materially defective PRODUCT. If the manufacturer repairs the PRODUCT, they may use new or refurbished replacement parts. If the manufacturer chooses to replace the PRODUCT, they may replace it with a new or refurbished PRODUCT of the same or similar design. The manufacturer will retain defective parts, modules, or equipment. Repair or replacement of the PRODUCT, at the manufacturer's option, is your exclusive remedy. The manufacturer will return repaired or replacement products to you in working condition. You should expect the repair or replacement to take approximately 30 days.

3. How long is the limited warranty period?

The limited warranty period for the PRODUCT extends for ONE (1) YEAR from the date of purchase. If the manufacturer repairs or replaces a materially defective PRODUCT under the terms of this limited warranty, this limited warranty also applies to repaired or replacement PRODUCT for a period of either (a) 90 days from the date the repaired or replacement PRODUCT is shipped to you or (b) the time remaining on the original one-year limited warranty; whichever is longer.

4. What is not covered by this limited warranty?

This limited warranty does not cover:

- ▶ PRODUCT that has been subjected to misuse, accident, shipping or other physical damage, improper installation, abnormal operation or handling, neglect, inundation, fire, water, or other liquid intrusion; or
- ▶ PRODUCT that has been damaged due to repair, alteration, or modification by anyone other than an authorized service representative of the manufacturer; or
- ▶ PRODUCT to the extent that the problem experienced is caused by signal conditions, network reliability or cable or antenna systems; or
- ▶ PRODUCT to the extent that the problem is caused by use with non-AT&T accessories; or
- ▶ PRODUCT whose warranty/quality stickers, PRODUCT serial number plates or electronic serial numbers have been removed, altered or rendered illegible; or
- ▶ PRODUCT purchased, used, serviced, or shipped for repair from outside the United States of America or Canada, or used for commercial or institutional purposes (including but not limited to products used for rental purposes); or
- ▶ PRODUCT returned without valid proof of purchase (see item 6); or
- ▶ Charges for installation or setup, adjustment of customer controls, and installation or repair of systems outside the unit.

5. How do you get warranty service?

To obtain warranty service, visit <https://telephones.att.com> or call **1 (800) 222-3111**. In Canada, dial **1 (866) 288-4268**.

Note: Before calling for service, please review the user's manual; a check of the PRODUCT's controls and features may save you a service call.

Except as provided by applicable law, you assume the risk of loss or damage during transit and transportation and are responsible for delivery or handling charges incurred in the transport of the PRODUCT(s) to the service location. The manufacturer will return repaired or replaced PRODUCT under this limited warranty to you. Transportation, delivery or handling charges are prepaid. The manufacturer assumes no risk for damage or loss of the PRODUCT in transit. If the PRODUCT failure is not covered by this limited warranty, or proof of purchase does not meet the terms of this limited warranty, the manufacturer

will notify you and will request that you authorize the cost of repair prior to any further repair activity. You must pay for the cost of repair and return shipping costs for the repair of products that are not covered by this limited warranty.

6. What must you return with the PRODUCT to get warranty service?

You must:

- a. Return the entire original package and contents including the PRODUCT to the service location along with a description of the malfunction or difficulty; and
- b. Include “valid proof of purchase” (sales receipt) identifying the PRODUCT purchased (PRODUCT model) and the date of purchase or receipt; and
- c. Provide your name, complete and correct mailing address, and telephone number.

7. Other limitations

This warranty is the complete and exclusive agreement between you and the manufacturer of this AT&T branded PRODUCT. It supersedes all other written or oral communications related to this PRODUCT. The manufacturer provides no other warranties for this PRODUCT. The warranty exclusively describes all of the manufacturer’s responsibilities regarding the PRODUCT. There are no other express warranties. No one is authorized to make modifications to this limited warranty and you should not rely on any such modification.

State/Provincial Law rights: This warranty gives you specific legal rights, and you may also have other rights which vary from state to state or province to province.

Limitations: Implied warranties, including those of fitness for a particular purpose and merchantability (an unwritten warranty that the PRODUCT is fit for ordinary use) are limited to one year from date of purchase. Some states/provinces do not allow limitations on how long an implied warranty lasts, so the limitation mentioned above may not apply to you. In no event shall the manufacturer be liable for any indirect, special, incidental, consequential, or similar damages (including, but not limited to lost profits or revenue, inability to use the PRODUCT or other associated equipment, the cost of substitute equipment, and claims by third parties) resulting from the use of this PRODUCT. Some states/provinces do not allow the exclusion or limitation of incidental or consequential damages, so the limitation or exclusion mentioned above may not apply to you.

Please retain your original sales receipt as proof of purchase.

Technical specifications

RF frequency band	1921.536MHz — 1928.448MHz
Channels	5
Telephone base voltage (AC voltage, 60Hz)	96 — 129 Vrms
Telephone base voltage (DC adapter output)	6VDC @400mA
Handset voltage	2.4 VDC, AAA x 2, Ni-MH
Charger voltage (AC adapter output)	6VDC @400mA
Operating times*	Talk time (handset): up to 7 hours Standby: up to 5 days

* Operating times vary depending on your actual use and the age of the battery.

Company: Advanced American Telephones

Address: 9020 SW Washington Square Road - Ste 555 Tigard, OR 97223, United States.

Phone: 1 (800) 222-3111 in the U.S. or 1 (866) 288-4268 in Canada



Telephones identified with this logo have reduced noise and interference when used with most T-coil equipped hearing aids and cochlear implants. The TIA-1083 Compliant Logo is a trademark of the Telecommunications Industry Association. Used under license.



The ENERGY STAR® program (www.energystar.gov) recognizes and encourages the use of products that save energy and help protect our environment. We are proud to supply this product with an ENERGY STAR® qualified power adapter meeting the latest energy efficiency guidelines.

The *Bluetooth*® word mark and logos are owned by Bluetooth SIG, Inc. and any use of such marks by Advanced American Telephones and its parent, VTech Holdings Limited, is under license. VTech Holdings Limited is a member of Bluetooth SIG, Inc. Other trademarks and trade names are those of their respective owners.

©2019-2020 Advanced American Telephones. All Rights Reserved.

AT&T and the AT&T logo are trademarks of AT&T Intellectual Property licensed to Advanced American Telephones, San Antonio, TX 78219.

Siri® is a registered trademark of Apple Inc.

Android® is a registered trademark of Google Inc.

Connect to Cell™ is a trademark of Advanced American Telephones.

Google Now™ is a trademark of Google Inc.

IOS is a trademark or registered trademark of Cisco in the U.S. and other countries and is used under license.

Qaltel™ is a trademark of Truecall Group Limited.

S Voice® is a registered mark of Samsung Electronics Co., Ltd.

The RBRC Seal and 1-800-8-BATTERY® are registered trademarks of Call2recycle, Inc.

Printed in China. Issue 5.0 AT&T 10/20.